



A48100 Unit

User Manual

Contents

Statement of Law	2
Safety Precautions	3
Preface	4
1 Introduction	4
1.1 Brief Introduction	4
1.2 Product Properties	4
1.3 Product identity definition	5
2 Product Specification	5
2.1 Size and Weight	5
2.2 Performance Parameter	5
2.3 Interface Definition	5
2.3.1 DIP switch definition and description.....	6
2.4 Battery Management System(BMS)	9
2.4.1 Voltage Protection.....	9
2.4.2 Current Protection.....	9
2.4.3 Temperature Protection.....	10
2.4.4 Other Protection.....	10
3 Installation and Configuration	11
3.1 Preparation for installation	11
3.1.1 Environmental requirements.....	11
3.1.2 Tools and data.....	11
3.1.3 Technical preparation.....	12
3.1.4 Unpacking inspection.....	12
3.1.5 Engineering coordination.....	14
3.2 Equipment installation	14
3.2.1 Installation preparation.....	15
3.2.2 Mechanical installation.....	15
3.2.3 Electrical installation.....	17
3.2.4 Battery parameter settings on the inverter.....	20
3.2.5 Register on the website after installation.....	20
4 Use, maintenance and troubleshooting	21
4.1 Battery system usage and operation instructions	21
4.2 Alarm description and processing	21
4.3 Analysis and treatment of common faults	22

Statement of Law

Copyright of this document belongs to Daqin New Energy Tech (Taizhou) Co., Ltd.

No part of this documentation maybe excerpted, reproduced, translated, annotated or duplicated in any form or by any means without the prior written permission of Daqin New Energy Tech (Taizhou) Co., Ltd. All Rights Reserved.

This product complies with the design requirements of environmental protection and personal safety. The storage, use and disposal of the products shall be carried out in accordance with the product manual, relevant contract or relevant laws and regulations.

Customer can check the related information on the website of Daqin New Energy Tech (Taizhou) Co., Ltd when the product or technology is updated.

Web URL: <http://www.dyness-tech.com.cn>

Please note that the product can be modified without prior notice.

Revision History

Revision NO.	Revision Date	Revision Reason
1.0	2021.01.10	1.First Published
1.1	2021.09.06	1.Charge Voltage in page 5,is changed to 53.5V 2.Power cable overcurrent capacity is changed to 120A 3.Update DIP switch description. 4.Update charge current limit value to 1A in protection mode. 5.Update some recommended parameters in page 20. 6.Change the Min.work voltage to 42v in page 21 7.Update some voltage value in page 22.

Safety Precautions

Warning

- Please do not put the battery into water or fire, in case of explosion or any other situation that might endanger your life.
- Please connect wires properly while installation, do not reverse connect.
- To avoid short circuit, please do not connect positive and negative poles with conductor on the same device.
- Please avoid any form of damage to battery, especially stab, hit, trample or strike.
- Please shut off the power completely when removing the device or reconnecting wires during the daily use or it could cause the danger of electric shock.
- Please use dry powder extinguisher to put out the flame when encountering a fire hazard, liquid extinguisher could result in the risk of explosion.
- For your safety, please do not arbitrarily dismantle any component in any circumstances. The maintenance must be implemented by authorized technical personnel or our company's technical support. Device breakdown due to unauthorized operation will not be covered under warranty.



Caution

- Our products have been strictly inspected before shipment. Please contact us if you find any abnormal phenomena such as device outer case bulging.
- The product shall be grounded properly before use in order to ensure your safety.
- To assure the proper use please make sure parameters among the relevant device are compatible and matched.
- Please do not mixed-use batteries from different manufacturers, different types and models, as well as old and new together.
- Ambient and storage method could impact the product life span, please comply with the operation environment instruction to ensure device works in proper condition.
- For long-term storage, the battery should be recharged once every 6 months, and the amount of electric charge shall exceed 80% of the rated capacity.
- Please charge the battery in 18 hours after it fully discharged or over-discharging protection mode is activated.
- Formula of theoretical standby time: $T=C/I$ (T is standby time, C is battery capacity, I is total current of all loads).

Preface

Manual declaration

A48100 lithium iron phosphate battery energy storage system can be combined in series or parallel to provide energy storage function for photovoltaic power generation users. Our product can store extra electricity into battery from photovoltaic power generation system in daytime and supply stable power to user's equipment as power backup at nighttime or any time when needed. It can improve the efficiency of photovoltaic power generation and increase the electric power efficiency by peak load shifting.

This user manual details the basic structure, parameters, basic procedures and methods of installation and operation and maintenance of the equipment.

1 Introduction

1.1 Brief Introduction









A48100 lithium iron phosphate battery system is a standard battery system unit, customers can choose a certain number of A48100 according to their needs, by connecting parallel to form a larger capacity battery pack, to meet the user's long-term power supply needs. The product is especially suitable for energy storage applications with high operating temperatures, limited installation space, long power backup time and long service life.

1.2 Product Properties

A48100 energy storage product's positive electrode materials are lithium iron phosphate, battery cells are managed effectively by BMS with better performance, the system's features as below:

- Comply with European ROHS, Certified SGS, employ non-toxic, non-pollution environment-friendly battery.
- Anode materials are lithium iron phosphate (LiFePO₄), safer with longer life span.
- Carries battery management system with better performance, possesses protection function like over-discharge, over-charge, over-current, abnormal temperature.
- Self-management on charging and discharging, Single core balancing function.
- Intelligent design configures integrated inspection module.
- Flexible configurations allow parallel of multi battery for longer standby time.
- Self-ventilation with lower system noise.
- Less battery self-discharge, then recharging period can be up to 10 months during the storage.
- No memory effect so that battery can be charged and discharged shallowly.
- With wide range of temperature for working environment, -20°C ~ +55°C, circulation span and discharging performance are well under high temperature.
- Less volume, lighter weight.







1.3 Product identity definition





	Battery voltage is higher than safe voltage, direct contact with electric shock hazard.
	flammable.
	Read the user manual before using.
	The scrapped battery cannot be put into the garbage can and must be professionally recycled.
	After the battery life is terminated, the battery can continue to be used after it recycled by the professional recycling organization and do not discard it at will.
	Do not place near open flame or incinerate.
	If catch fire, do not put out with water.
	If catch fire, do not put out with dry powder fire extinguisher.
	Do not cut or spear with sharp objects.

DYNESS ENERGY STORAGE SYSTEM WWW.DYNESS-TECH.COM.CN

Module: LFP Lithium Ion Battery
 Type: A48100
 Capacity/Voltage: 100Ah/48V
 Total Storing Energy: 4.8kWh
 Charge Voltage: 52.5~54V
 Max.Discharge Power: 3.6kW
 Series Number:
 Manufacture Date:

WARNING

-  * Do not disconnect, disassemble or repair by yourself.
-  * Do not drop, deform, impact, cut or spear with a sharp object.
-  * Do not place near open flame or incinerate.
-  * Do not sit or put heavy things on battery.
-  * Keep away from moisture or liquid.
-  * Keep out of reach of children, animals or insects.
-  * Contact the supplier within 24 hours if anything wrong.

DAQIN NEW ENERGY TECH(TAIZHOU) CO., LTD

2 Product Specification

2.1 Size and Weight

Table 2-1 A48100 Device size

Product	Nominal Voltage	Nominal Capacity	Dimension	Weight
A48100	DC48V	100Ah	504×597×155mm	≈45kg

2.2 Performance Parameter

Table 2-2 A48100 performance parameter

Item	Parameter value
Nominal Voltage(V)	48
Work Voltage Range(V)	42~54
Nominal Capacity(Ah)	100
Nominal Energy(kWh)	4.8
Recommended Charge/Discharge Current (A)	50
Max. Power Charge/Discharge Current (A)	75
Peak Power Charge/Discharge Current (A)	100 (15S)
Charge Voltage (Vdc)	53.5

2.3 Interface Definition

This section elaborates the interface functions of the front interface of the device.

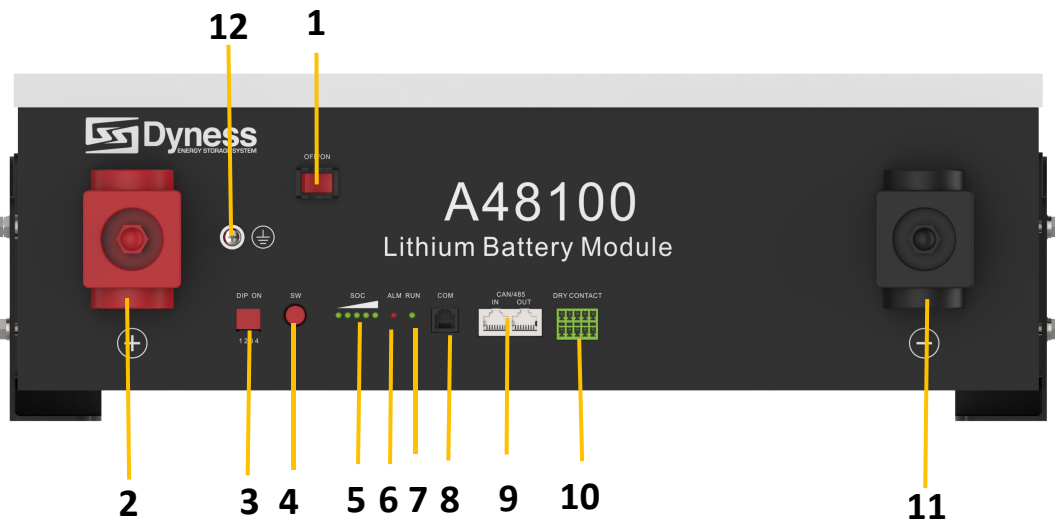

Figure2-1 The sketch of interface.

Table 2-3 Interface Definition

Item	Name	Definition
1	Power switch	OFF/ON, must be in the "ON" state when in use
2	Positive socket	Battery output positive or parallel positive line
3	ADD	DIP switch
4	SW (battery wake/sleep switch)	When the "OFF/ON" switch button is in the ON state, press and hold this button for 3 seconds to put the battery into the power-on or off state.
5	SOC	The number of green lights shows the remaining power. Table 2-3 for details.
6	ALM	Red light flashing when an alarm occurs, red light always on during protection status. After the condition of trigger protection is relieved, it can be automatically closed.
7	RUN	Green light flashing during standby and charging mode. Green light always on when discharging.
8	COM	Communication cascade port, support RS232
9	CAN/485	Communication cascade port, support CAN/ RS485 communication (factory default CAN communication)
10	DRY CONTACT	/
11	Negative socket	Battery output negative or parallel negative line
12	Grounding	Shell ground connection

2.3.1 DIP switch definition and description

Table 2-4 Interface Definition

DIP switch position (master communication protocol and baud rate selection)			
#1	#2	#3	#4
Define different protocols; Distinguish between master and slave			Baud rate selection
			OFF: CAN: 500K,485: 9600
			ON: CAN: 250K,485: 115200

DIP switch description:

When the batteries are connected in parallel, the host communicates with the slaves through the CAN interface. The host summarizes the information of the entire battery system and communicates with the inverter through CAN or 485.

1. If the master is the latest A48100 battery with DIP switch:

(1) The communication cable from the master CAN IN to the inverter comm port should be the correct one.

(2) When the battery works with GOODWE、Solis、LUX、Sofar、DEYE、VICTRON、IMEON、Sungrow、SMA、RENAC、DELIOS、SAJ(CAN Comm) ,before starting the battery,you need put the master DIP switch "# 3" to the "ON" position (to the top), then turn on the batteries.



(3) If the battery communicates with the Axpert-king/VMIII/MAX,Infinisolar,Growatt SPH/SPA(CAN comm)、GMDE, turn the master DIP switch "#2" to "ON" position.



(4) If the battery communicates with the Growatt SPF HVM-P/ES/WPV by RS485 communication, turn the master DIP switch "#2" and "#3" to "ON".



(5) If the battery communicates with the Schneider Conext Series, turn the master DIP switch "#1" and "#3" to "ON".



(6) When you setup the master DIP as setting 1~4,all the slaves keep the DIP 0000,no need change.

(7) If the energy storage system has only one A48100, it is the master itself, and still follow the above steps.

Note: For more information of matching inverter brands, please subject to the latest document

<The list of compatibility between Dynergy ESS and Inverters >.

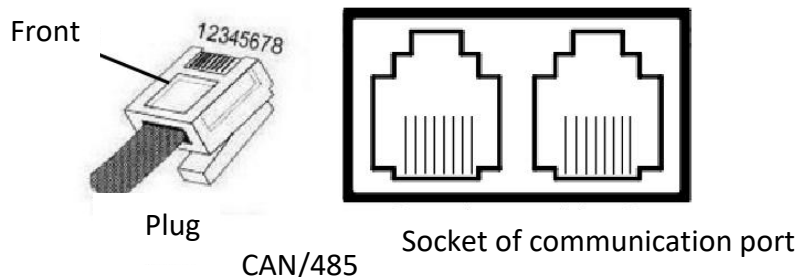
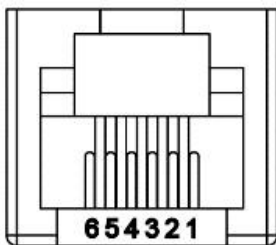

Figure 2-2 CAN/485 interface definition

Table 2-5 Pin Definition

Foot position	Color	Definition
PIN1	Orange/white	485B
PIN2	Orange	485A
PIN3	Green/white	XGND
PIN4	Blue	CANH
PIN5	Blue/white	CANL
PIN6	Green	Reserve
PIN7	Brown/white	XIN
PIN8	Brown	Reserve
PIN9	Orange/white	Reserve
PIN10	Orange	Reserve
PIN11	Green/white	XGND
PIN12	Blue	CANH
PIN13	Blue/white	CANL
PIN14	Green	Reserve
PIN15	Brown/white	XOUT
PIN16	Brown	Reserve



Foot position	Definition
PIN1	Reserve
PIN2	GND
PIN3	TXD
PIN4	RXD
PIN5	GND
PIN6	Reserve

Figure 2-3 COM interface definition

Tips: Please pay attention of the communication com definition of inverter, in order to avoid voltage in the port to affect communication.

Table 2-6 LED status indicators

Battery Status	SOC	LED1	LED2	LED3	LED4	LED5	ALM	RUN
Shutdown	/	off	off	off	off	off	off	off
Standby	80% < SOC ≤ 100%	●	●	●	●	●	off	Flashing
	60% < SOC ≤ 80%	●	●	●	●	off	off	Flashing
	40% < SOC ≤ 60%	●	●	●	off	off	off	Flashing
	20% < SOC ≤ 40%	●	●	off	off	off	off	Flashing
	0% < SOC ≤ 20%	●	off	off	off	off	Flashing	Flashing
	SOC=0	off	off	off	off	off	Flashing / ●	Flashing
Charging	SOC=100%	●	●	●	●	●	off	Flashing
	80% < SOC < 100%	●	●	●	●	Flashing	off	Flashing
	60% < SOC ≤ 80%	●	●	●	Flashing	off	off	Flashing
	40% < SOC ≤ 60%	●	●	Flashing	off	off	off	Flashing
	20% < SOC ≤ 40%	●	Flashing	off	off	off	off	Flashing
	0% ≤ SOC ≤ 20%	Flashing	off	off	off	off	off	Flashing
Discharging	80% < SOC ≤ 100%	●	●	●	●	●	off	●
	60% < SOC ≤ 80%	●	●	●	●	off	off	●
	40% < SOC ≤ 60%	●	●	●	off	off	off	●
	20% < SOC ≤ 40%	●	●	off	off	off	off	●
	0% < SOC ≤ 20%	●	off	off	off	off	Flashing	●
	SOC=0	off	off	off	off	off	Flashing / ●	Flashing / ●

A special ALM light flashing state: when the communication between batteries is lost or abnormal, all the lights from SOC to RUN of the master battery will flash together.

● means green light always on ● means red light always on
Flashing: means green light flashing or red light flashing

2.4 Battery Management System(BMS)

2.4.1 Voltage Protection

Low Voltage Protection in Discharging :

When any battery cell voltage or total voltage is lower than the rated protection value during discharging, the over-discharging protection is activated, and the battery buzzer makes an alarm sound. Then battery system stops supplying power to the outside. When the voltage of each cell back to rated return range, the protection is over.

Over Voltage Protection in Charging:

Battery will stop charging when total voltage or any battery cell voltage reaches the rated protection value during charging stage. When total voltage or all cell back to rated range, the protection is over.

2.4.2 Current Protection

Over Current Protection in Charging:

When the charge current $> 90A$, current limit protection mode is activated, current will be limited to $1A$, protection is removed after rated time delaying $10S$. Circulate like this until the current is lower than $90A$.

Over Current Protection in Discharging:

When the discharge current is higher than $100A$, the battery buzzer alarms and the system stops discharging after $15s$. After protection, the discharging will restore in $60s$ delay or immediately when there is charging current.



Caution:

The buzzer sound alarm setting can be manually turned off on the background software, and the factory default is on.

2.4.3 Temperature Protection

Low/Over temperature protection in charging:

When battery's temperature is beyond range of $-5^{\circ}C \sim +55^{\circ}C$ during charging, temperature protection is activated, device stops charging.

The protection is over when temperature back to rated working range.

Low/Over temperature protection in discharging:

When battery's temperature is beyond range of $-20^{\circ}C \sim +55^{\circ}C$ during discharging, temperature protection is activated, device stops supplying power to the outside.

The protection is over when temperature back to rated working range.

2.4.4 Other Protection

Short Circuit Protection:

When the battery is activated from the shutdown state, if a short circuit occurs, the system starts short-circuit protection for 60 seconds.

Self-Shutdown:

When device connects no external loads and power supply and no external communication for over 72 hours, device will dormant standby automatically.



Caution

Battery's maximum discharging current should be more than load's maximum working current.

3 Installation and Configuration

3.1 Preparation for installation

Safety Requirement

This system can only be installed by personnel who have been trained in the power supply system and have sufficient knowledge of the power system.

The safety regulations and local safety regulations listed below should always be followed during the installation.

- All circuits connected to this power system with an external voltage of less than 51.2V must meet the SELV requirements defined in the IEC60950 standard.
- If operating within the power system cabinet, make sure the power system is not charged. Battery devices should also be switched off.
- Distribution cable wiring should be reasonable and has the protective measures to avoid touching these cables while operating power equipment.
- when installing the battery system, must wear the protective items below:



The isolation gloves



Safety goggles



Safety shoes

Figure3-1

3.1.1 Environmental requirements

Working temperature: -20°C ~ +55°C

Charging temperature range is 0°C~+55°C,

Discharging temperature range is -20°C ~+55°C

Storage temperature: -10°C~ +35°C

Relative humidity: 5% ~ 85%RH

Elevation: no more than 4000m

Operating environment: Indoor installation, sites avoid the sun and no wind, no conductive dust and corrosive gas.

And the following conditions are met:

- Installation location should be away from the sea to avoid brine and high humidity environment.
- The ground for product arrangement shall be flat and level.
- No flammable explosive materials near the installation site.
- The optimal ambient temperature is 15°C~ 30 °C
- Keep away from dust and messy zones

3.1.2 Tools and data

Tools and meters that may be used are shown in table 3-1.

Table 3-1 Tool instrument

Name	
Screwdriver (Slotted、Phillips)	Multimeter
Torque wrench	Clamp current meter
Diagonal pliers	Insulation tape
Pointed nose pliers	Temperature meter
Pliers to hold the wire	Anti-static bracelet
Stripping pliers	Cable tie
Electric drill	Tape measure

3.1.3 Technical preparation

Electrical interface check

Devices that can be connected directly to the battery can be user equipment, power supplies, or other power supplies.

- Confirm whether the user's PV power generation equipment, power supply or other power supply equipment has a DC output interface, and measure whether the DC power output voltage meets the voltage range requirements in Table 2-2.
- Confirm that the maximum discharge current capability of the DC power interface of the user's photovoltaic power generation equipment, power supply or other power supply equipment should be higher than the maximum charging current of the products used in Table 2-2.

If the maximum discharge capacity of the DC power interface of the user's photovoltaic power generation equipment is less than the maximum charging current of the products used in Table 2-2, the DC power interface of the user's photovoltaic power generation equipment shall have a current limiting function to ensure the normal operation of the user's equipment.

- Verify that the maximum operating current of the battery-powered user equipment (inverter DC input) should be less than the maximum discharge current of the products used in Table 2-2.











The security check



- Firefighting equipment should be provided near the product, such as portable dry powder fire extinguisher.
- Automatic fire fighting system shall be provided for the case where necessary.
- No flammable, explosive and other dangerous materials are placed beside the battery.

3.1.4 Unpacking inspection

- When the equipment arrives at the installation site, loading and unloading should be carried out according to the rules and regulations, to prevent from being exposed to sun and rain.
- Before unpacking, the total number of packages shall be indicated according to the shipping list attached to each package, and the case shall be checked for good condition.
- In the process of unpacking, handle with care and protect the surface coating of the object.
- Open the package, the installation personnel should read the technical documents, verify the list, according to the configuration table and packing list, ensure objects are complete and intact, if the internal packing is damaged, should be examined and recorded in detail.

Packing list is as follows:

Item	Specification	Quantity	Figure
Battery-A48100	48V/100Ah	1	
Parallel cable-positive	Red /25mm ² /L250mm	1	
Parallel cable-negative	Black /25mm ² /L250mm	1	
Communication parallel cable	Black /L500mm/Double RJ45 plug	1	
Communication cable-to inverter	Black /L2000mm /Double RJ45 plug	1	
Ground wire	L500mm,4mm ²	1	
User Manual	User manual	1	
Screw	screws M6	8	
Expansion screw	Expansion screw	8	
cardboard	Positioning cardboard	1	

Battery bracket	Battery bracket	1	
Fixing bracket	Fixing bracket	1	

3.1.5 Engineering coordination

Attention should be paid to the following items before construction:

- Power line specification.
The power line specification shall meet the requirements of maximum discharge current for each product.
- Mounting space and bearing capacity.
Make sure that the battery has enough room to install, and that the brackets have enough load capacity.
- Wiring.
Make sure the power line and ground wire are reasonable. Not easy to short-circuit, water and corrosion.

3.2 Equipment installation

Table 3-2 Installation steps

Step1	Installation preparation	Confirm that the ON/OFF switch on the front panel of A48100 unit is in the "OFF" state to ensure no live operation.
Step 2	Mechanical installation	1. Battery placement position determination
		2. Battery module installation
Step3	Electrical installation	1. Ground cable installation
		2. Battery module parallel cable installation
		3. Parallel communication cable connection
Step4	Battery system self-test	1. Turn the ON/OFF switch to the "ON" state
		2. Press SW button 3S to wake up battery
		3. Check the system output voltage and led status
		4. Shut down the system
Step5	Connecting inverter	1. Connect total positive & total negative cable of the battery system to the inverter
		2. Battery module total positive cable installation
		3. Battery module total negative cable installation
		4. Connect the communication cable from the master CAN IN to the inverter
		5. Turn on the Power switch and wake up system by SW button
		6. Close the DC breaker between inverter and battery
		7. Turn on the inverter and check the communication between inverter and battery system

3.2.1 Installation preparation

1. Prepare equipment and tools for installation.
2. Check the A48100 unit and confirm that the ON/OFF switch is in the "OFF" state to ensure the device is shut off.

3.2.2 Mechanical installation

(1) Brackets Installation:

1. A48100 brackets The A48100 bracket is shown before installation as shown in figure3-2.

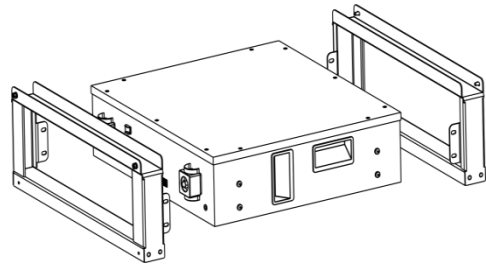

Figure3-2

2. Place the A48100 and brackets as shown in the figure3-3, and insert the A48100 into the brackets. Each bracket is connected to the module by four screws, two screws on one side. As shown in figure3-3.

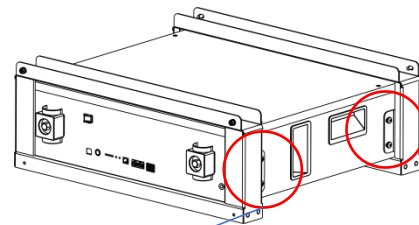
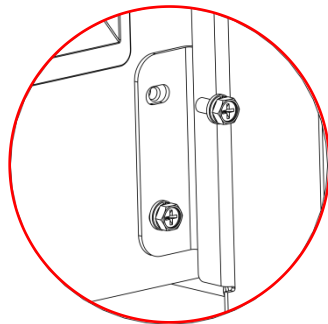

Figure3-3



3. Install another module as the same method, don't tighten the screw first, put it on top of the first battery, as shown in figure3-4.

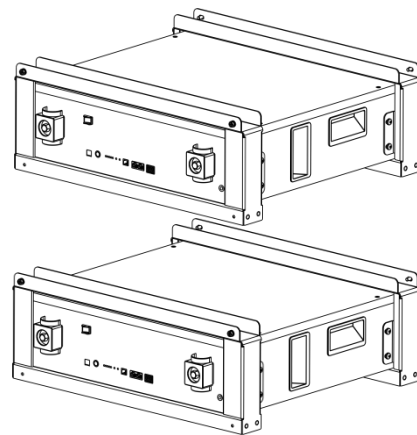

Figure3-4

4. Install all screws according to the hole position and there are screws on the front and back need to be fixed.

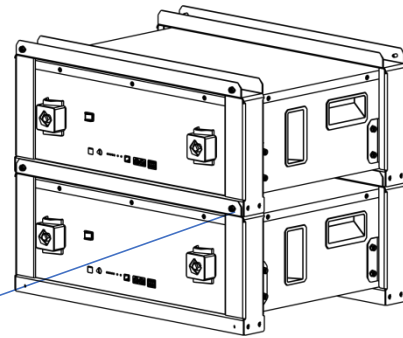
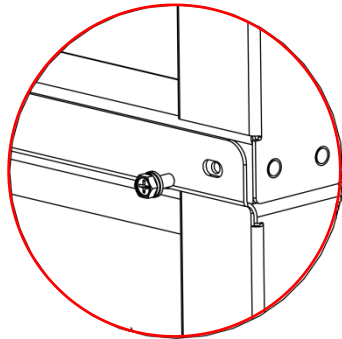

Figure3-5

5. Stack the required number of battery and bracket combinations as described above, and fix the screws, twisting force keeps 9.8N·m. Shown as Figure3-6.

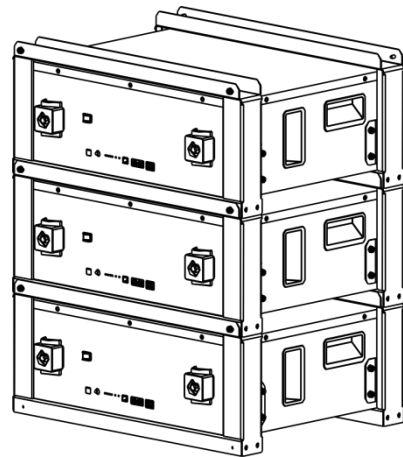

Figure3-6

(2) Wall hanging Installation method:

1. Use the positioning cardboard (provided in accessory package) and mark the screw hole positions on the wall, as shown on the right.
2. The cardboard must be perpendicular to the ground while drawing the holes.
3. The bottom of the cardboard is about 300mm from the ground.
4. According to the position of the mark, 8 holes in diameter 10mm and depth of more than 70mm are hit on the wall with an electric drill, which are used for fitting expansion bolt M6.

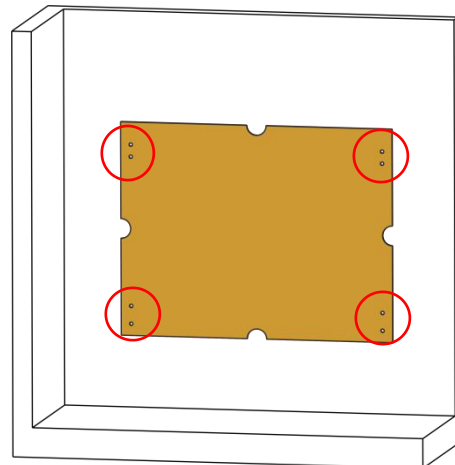

Figure3-7

5. Fixing the expansion bolt M6 into the bottom of the hole on the wall, and fix the Support bracket and Battery bottom bracket on the wall with M6 bolts. Twisting force keeps 9.8N·m.

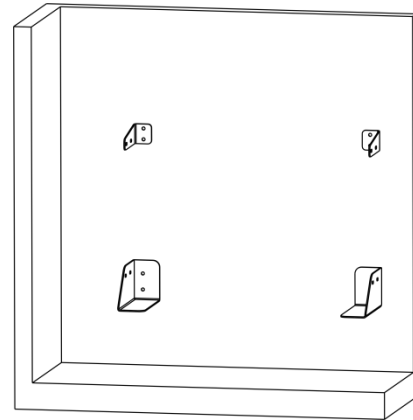

Figure3-8

6. Carry or hoist the battery box to the installed Battery bottom bracket. Fixing the Support bracket and the upper part of the battery box with M6 bolts, twisting force keeps 9.8N·m. Then fixing the Battery bottom bracket and the bottom part of the battery box with M6 bolts. Twisting force keeps 9.8N·m.

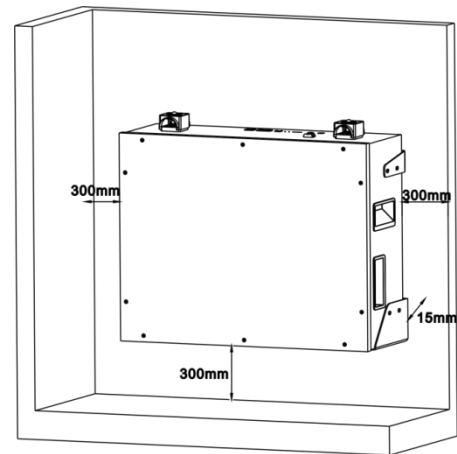

Figure3-9

3.2.3 Electrical installation

Before connecting the power cables, use multimeter to measure cable continuity, short circuit, confirm positive and negative, and accurately mark the cable labels.

Measuring methods:

- Power cable check: select the buzzer mode of multimeter and detect the both ends of the same color cable. If the buzzer calls, it means the cable is in good condition.
- Short circuit judgment: choose multimeter resistor file, probe the same end of positive and negative pole, if the resistor shows infinity, means that the cable is available.
- After visual testing of power line connection, the positive and negative poles of the battery shall be connected respectively to the positive and negative poles of the opposite terminal.

It is better to add a circuit breaker between the inverter and the battery system. The selection of the circuit breaker requires:

Voltage: $U > 60V$

$$\text{Current: } I = \frac{\text{Inverter power}}{45V}$$

The circuit breaker is installed between the battery module and the inverter, as shown in Figure 3-10:

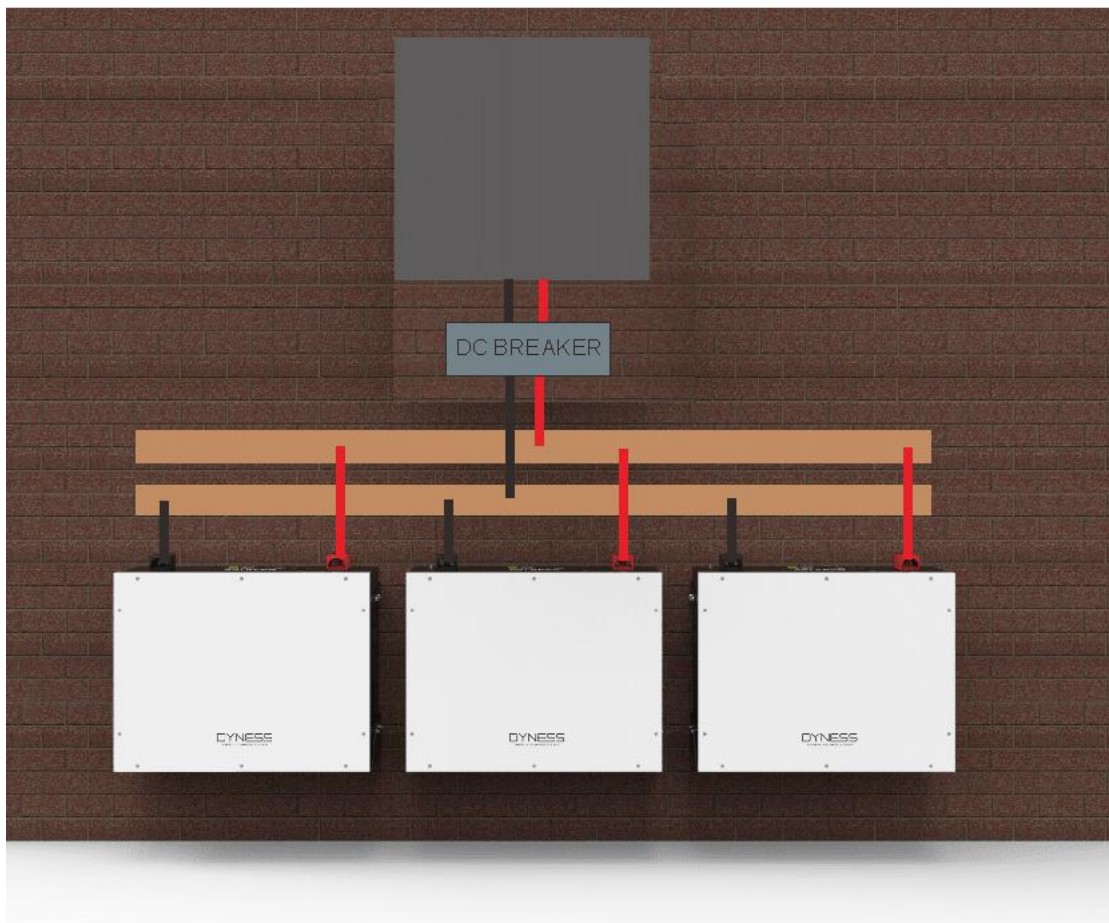
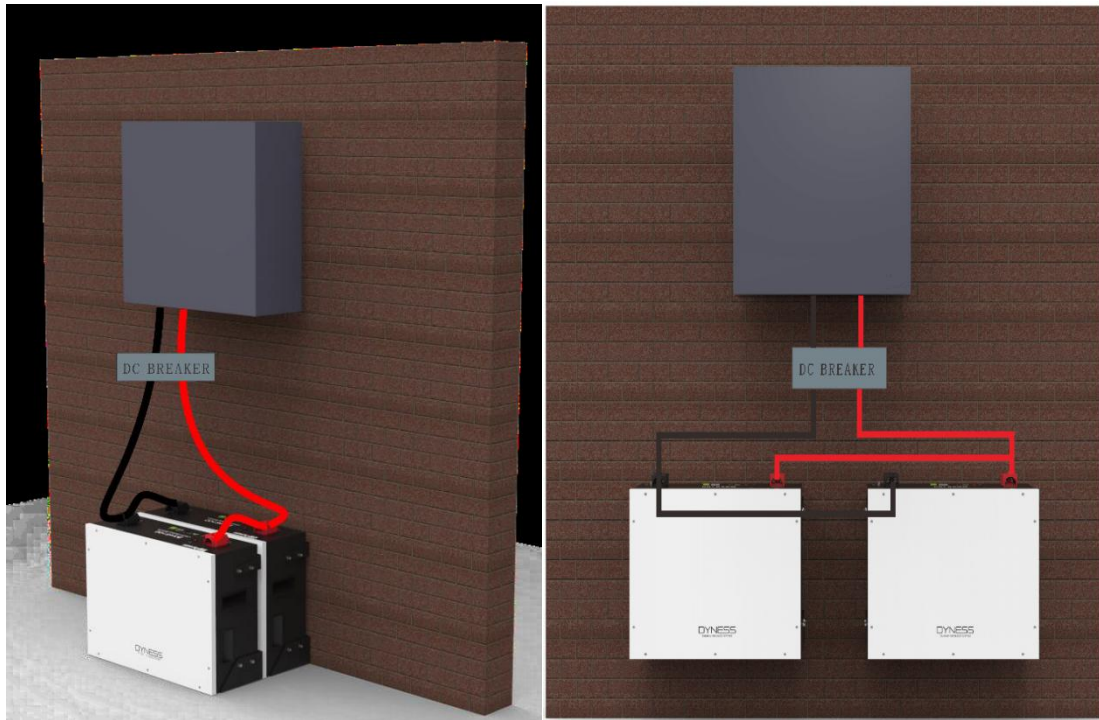

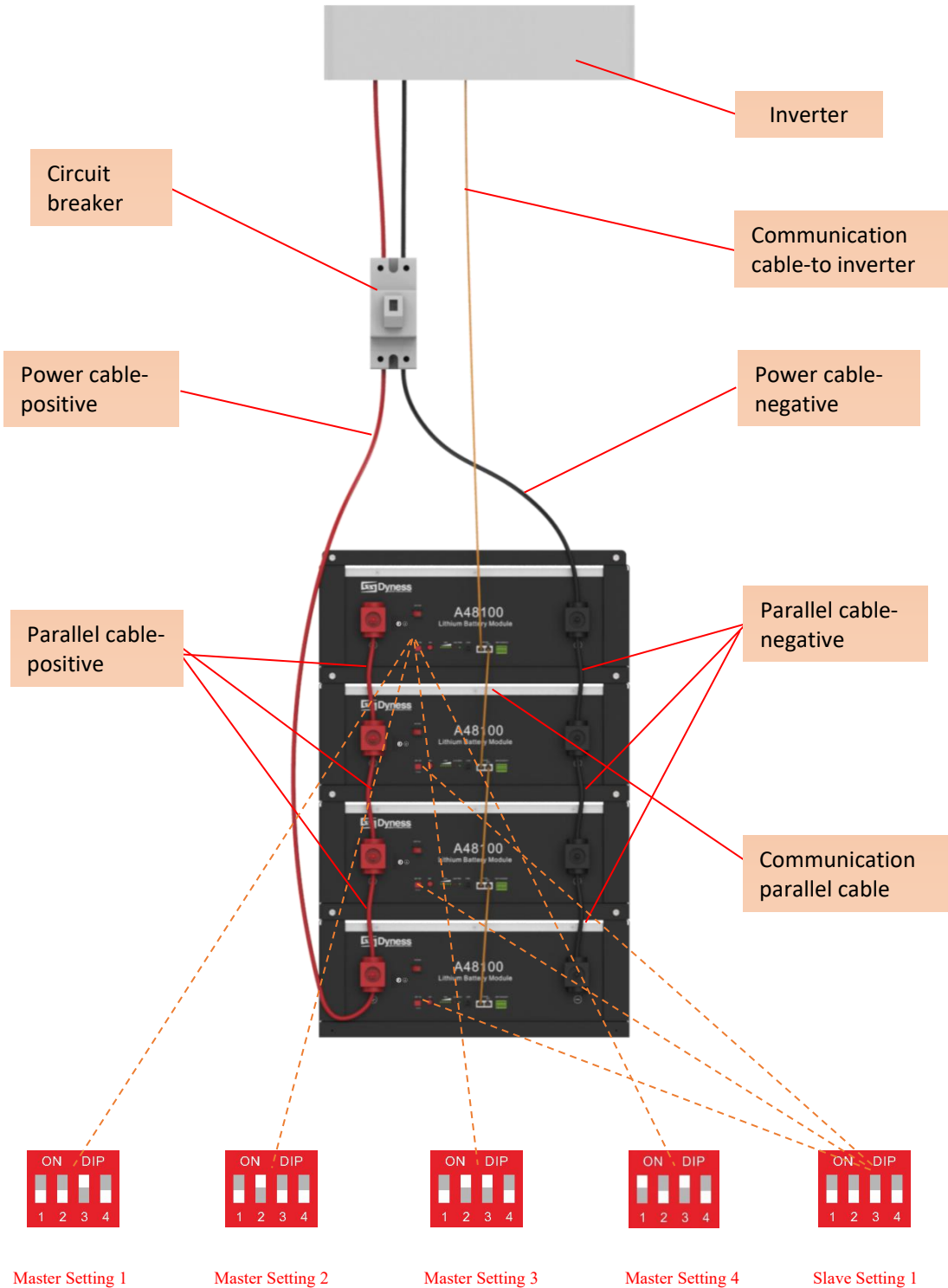

Figure3-10

Note:

1. For more ADD Settings, Reference 2.3.1 “DIP switch definition and description”
2. After the whole system connection, set the master DIP mode according to the inverter model firstly, then start the battery.
3. The BAT-INV comms cable is from inverter comm port to master CAN IN port, BAT-BAT cable is from master CAN OUT to slave1 CAN IN, slave1 CAN OUT to slave2 CAN IN...
4. Each pair of power cable, it’s limited continuous current is 120A, so if the inverter Max. work current more than 120A, please add power cable according to the proportion.

3.2.4 Battery parameter settings on the inverter

Max Charging(Bulk) Voltage: 53.5V

Absorption Voltage: 53V

Float Voltage: 52.5V

Shut Down(cut off) Voltage: 47V

Shut Down(cut off) SOC: 20%

Restart Voltage: 49V

Max Charge Current: 50A*battery QTY

Max Discharge Current: 50A*battery QTY

3.2.5 Register on the website after installation

After the battery system installation is completed and the running is normal, you need to log in to the DYNESSE official website to register the product installation and use information to make the product warranty effective. Please follow the instructions on the website to register.

<http://www.dyness-tech.com.cn>  Service  Sign Up

4 Use, maintenance and troubleshooting

4.1 Battery system usage and operation instructions

After completing the electrical installation, follow these steps to start the battery system.

1. Refer to the description of the DIP switch of 2.3.1 to prepare the battery module before starting up, then press the ON/OFF button to the ON position, press and hold the SW button for 3 seconds.
2. After the indicator self-test, the RUN indicator will light and the SOC indicator will be on (100% SOC status in the Figure4-1).

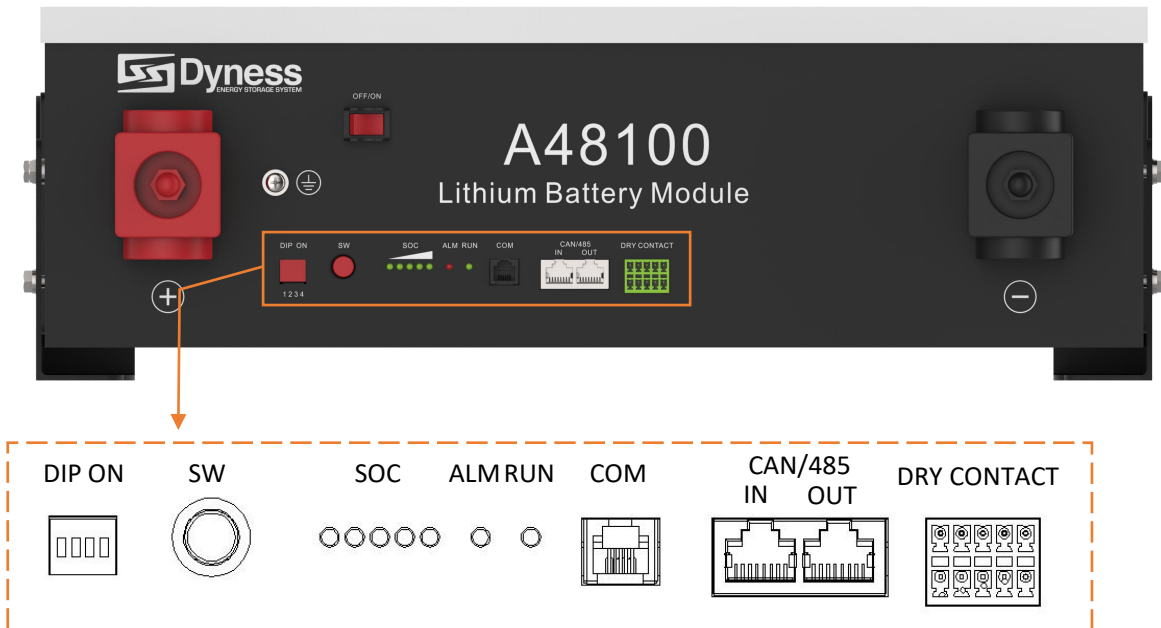

Figure4-1



Caution:

1. After pressing the power button, if the battery status indicator on the front panel continues to be red, please refer to the "4.2 Alarm description and processing". If the failure cannot be eliminated, please contact the dealer timely.
2. Use a voltmeter to measure whether the voltage of the circuit breaker battery access terminal is higher than 42V, and check whether the voltage polarity is consistent with the inverter input polarity. If the circuit breaker battery input terminal has a voltage output and is greater than 42V, then the battery begun to work normally.
3. After confirming that the battery output voltage and polarity are correct, turn on the inverter, close the circuit breaker.
4. Check if the indicator of the inverter and battery connection (communication indicator and battery access status indicator) is normal. If it is normal, successfully complete the connection between the battery and the inverter. If the indicator light is abnormal, please refer to the inverter manual for the cause or contact the dealer.

4.2 Alarm description and processing

When protection mode is activated or system failure occurred, the alarm signal will be given through the working status indicator on the front panel of the A48100. The network management can query the specific alarm categories.

If the fault such as single cell over voltage, charging over-current, under-voltage protection, high-temp protection and other abnormalities which affects the output, please deal with it according to Table 4-1.

Table 4-1 Main alarm and Protection

Statue	Alarm category	Alarm indication	Processing
Charge state	Over-current	RED Buzzer start	Stop charging and find out the cause of the trouble
	High temp	RED	Stop charging
Discharge state	Over-current	RED Buzzer start	Stop discharging and find out the cause of the trouble
	High temp	RED	Stop discharging and find out the cause of the trouble
	Total voltage undervoltage	RED Buzzer start	Start charging
	Cell voltage undervoltage	RED Buzzer start	Start charging

4.3 Analysis and treatment of common faults

Analysis and treatment of common faults in the Table 4-2:

Table 4-2 Analysis and treatment of common faults

No.	Fault phenomenon	Reason analysis	Solution
1	The indicator does not respond after the power on	Total voltage lower than 35V	Check the total voltage
2	No DC output	Battery data status is abnormal. Battery gets into over-discharged protection	Read the battery information on the monitor.
3	The DC power supply time is too short	Battery capacity become smaller	Storage battery replacement or add more modules
4	The battery can't be fully charged to 100%	Charging voltage is too low	Adjust charging voltage at 53.5V or 54V
5	The power cable sparks once power on and ALM light RED	Power connection short-circuit	Turn off the battery, check the cause of the short circuit
6	Communication fault	The DIP setting of the host is wrong/ the battery type of the inverter is wrong/ Communication cable used incorrectly/The communication cable is incorrectly connected at the battery communication port or the inverter communication port/The battery firmware version is too low to support the inverter	Check these possible causes one by one

If you need any technical help or have any question, please contact the dealer in time.

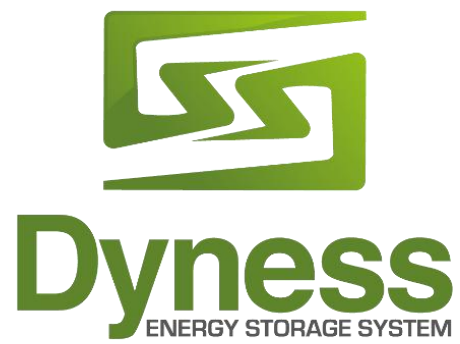

DAQIN NEW ENERGY TECH (TAIZHOU) Co.,LTD
Address: Building 13, Jiangyan Industrial Park, Sanshui Street,
Jiangyan District, Taizhou City, Jiangsu Province, 225500
Email: sales@dyness-tech.com
Website: www.dyness-tech.com.cn